

WIND SIM MOUNT

INSTRUCTION MANUAL

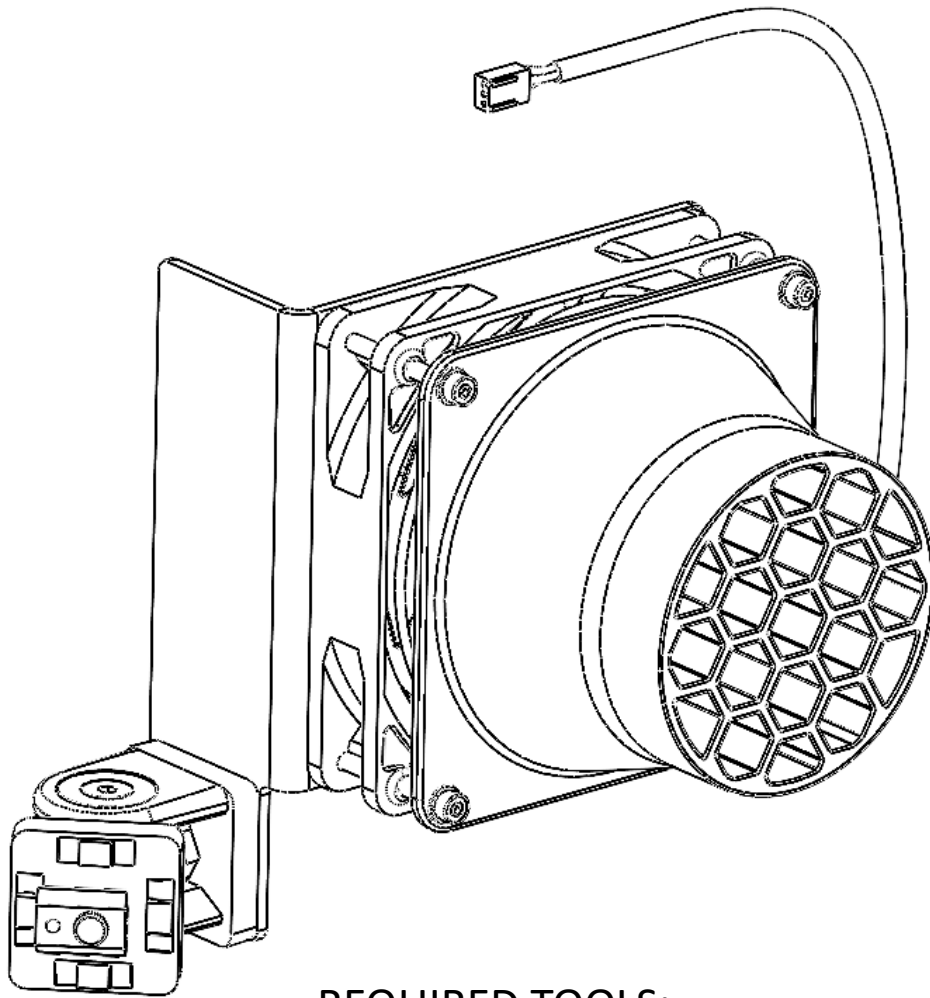

REQUIRED TOOLS:



3-6 mm

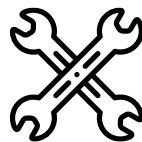

7 mm



1

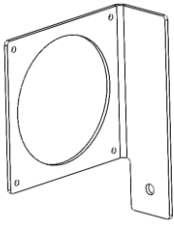

Left Plate

1x

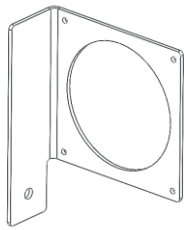

Right Plate

1x

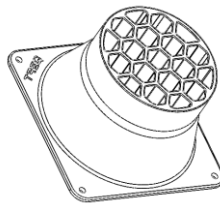

Diffuser

2x

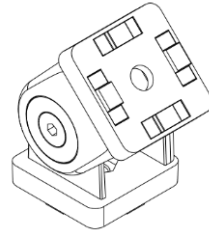

Hinge 4040

2x

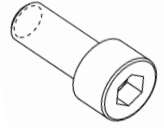

M8x16

4x

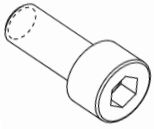

M4x40

8x



Plain Washer M4

16x

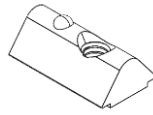

Click-in Nut M8

2x

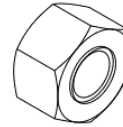

Nut M8

2x

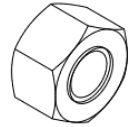

Nut M4

8x

2

