

REAR VIEW MIRROR

INSTRUCTION MANUAL

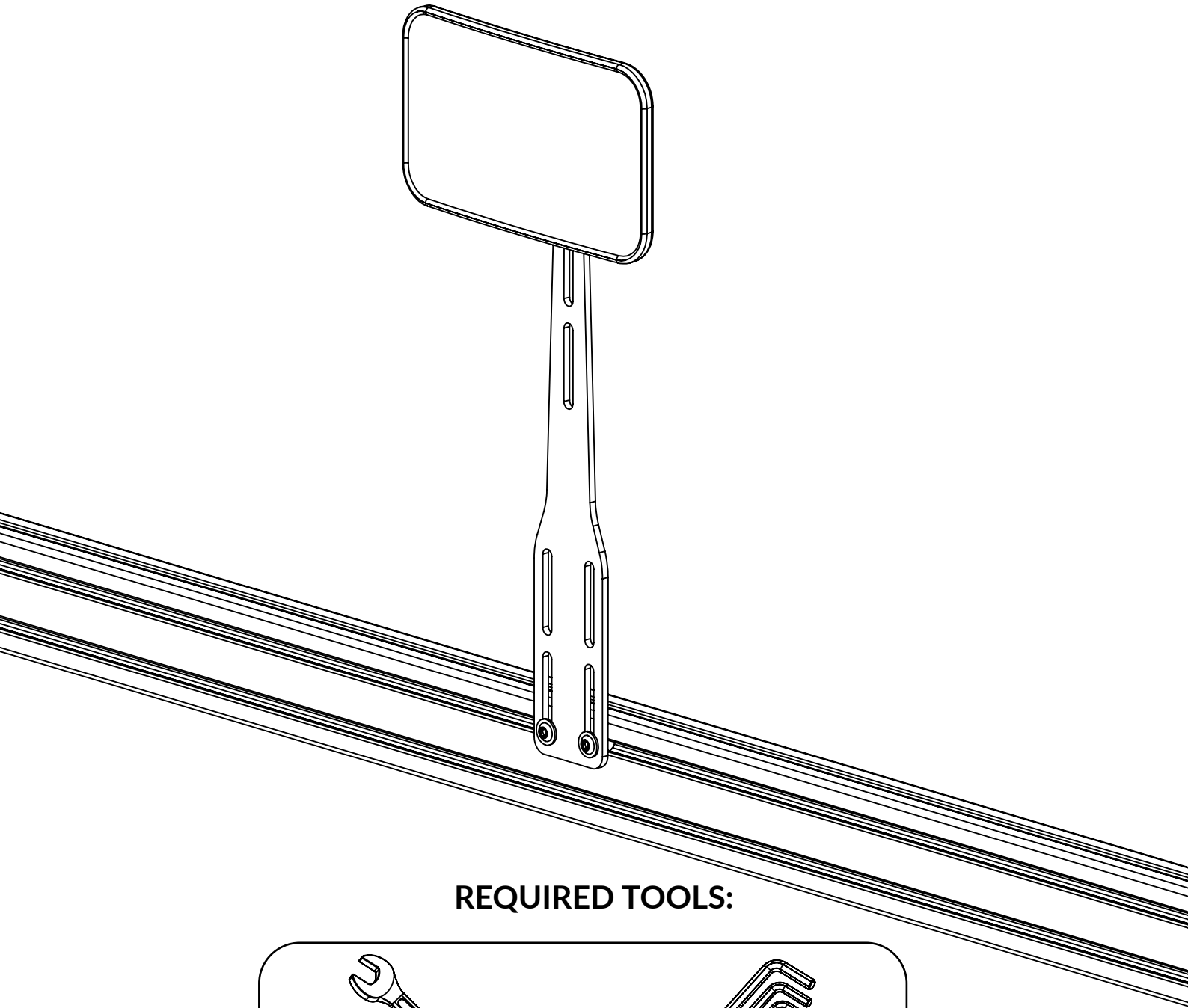

REQUIRED TOOLS:

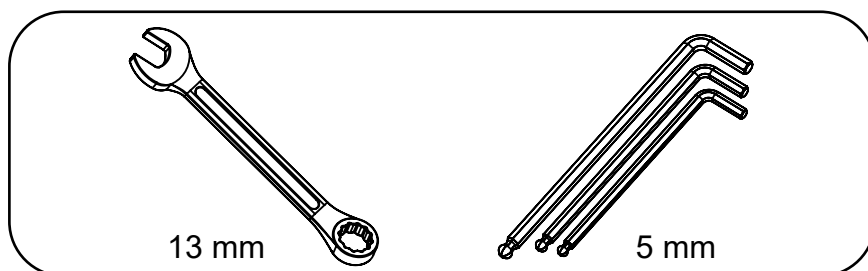

GENERAL INSTRUCTIONS

The easiest way to mount the T-Slot Click-in-Nuts, is to slide them in from one side of the profile, with the ball facing down. But don't worry if you need to put in a click-in-nut in a profile which has both ends already closed: it is also possible to push them in the T-slot anywhere you like!

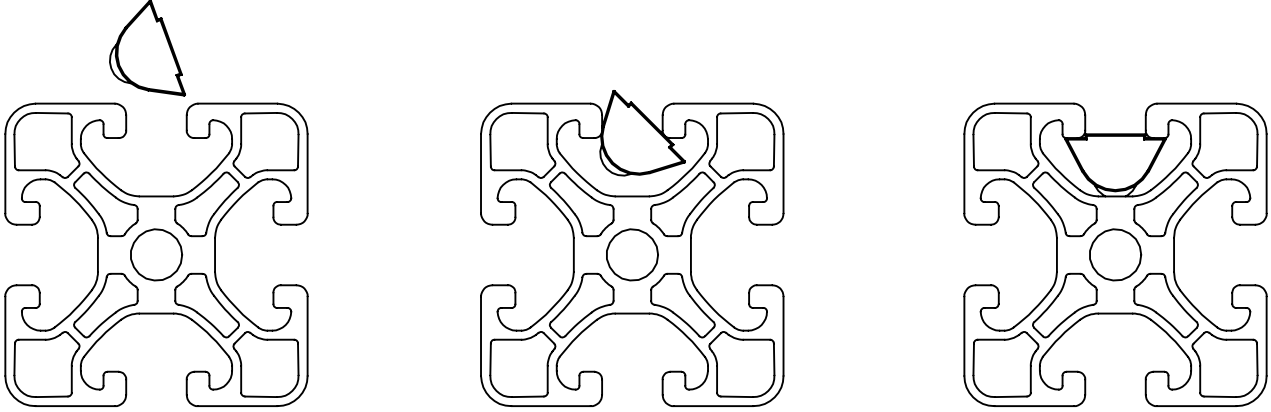

INCLUDED ITEMS

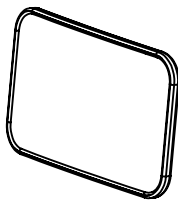

Mirror
1x

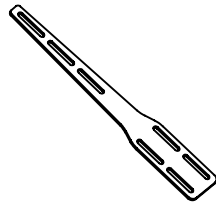

Mounting Bracket
1x



M8 T-Nut
2x

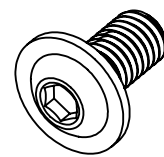

M8x16 Flange
2x

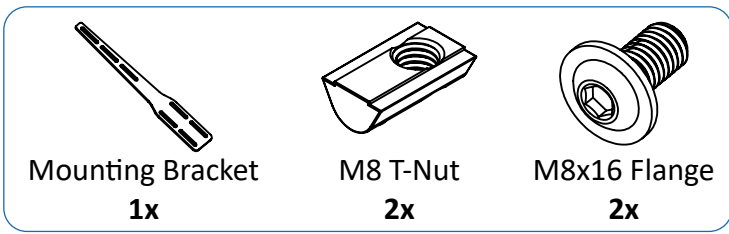

1

Attach the mounting bracket to any profile you desire.
You can use any slotted hole you like.

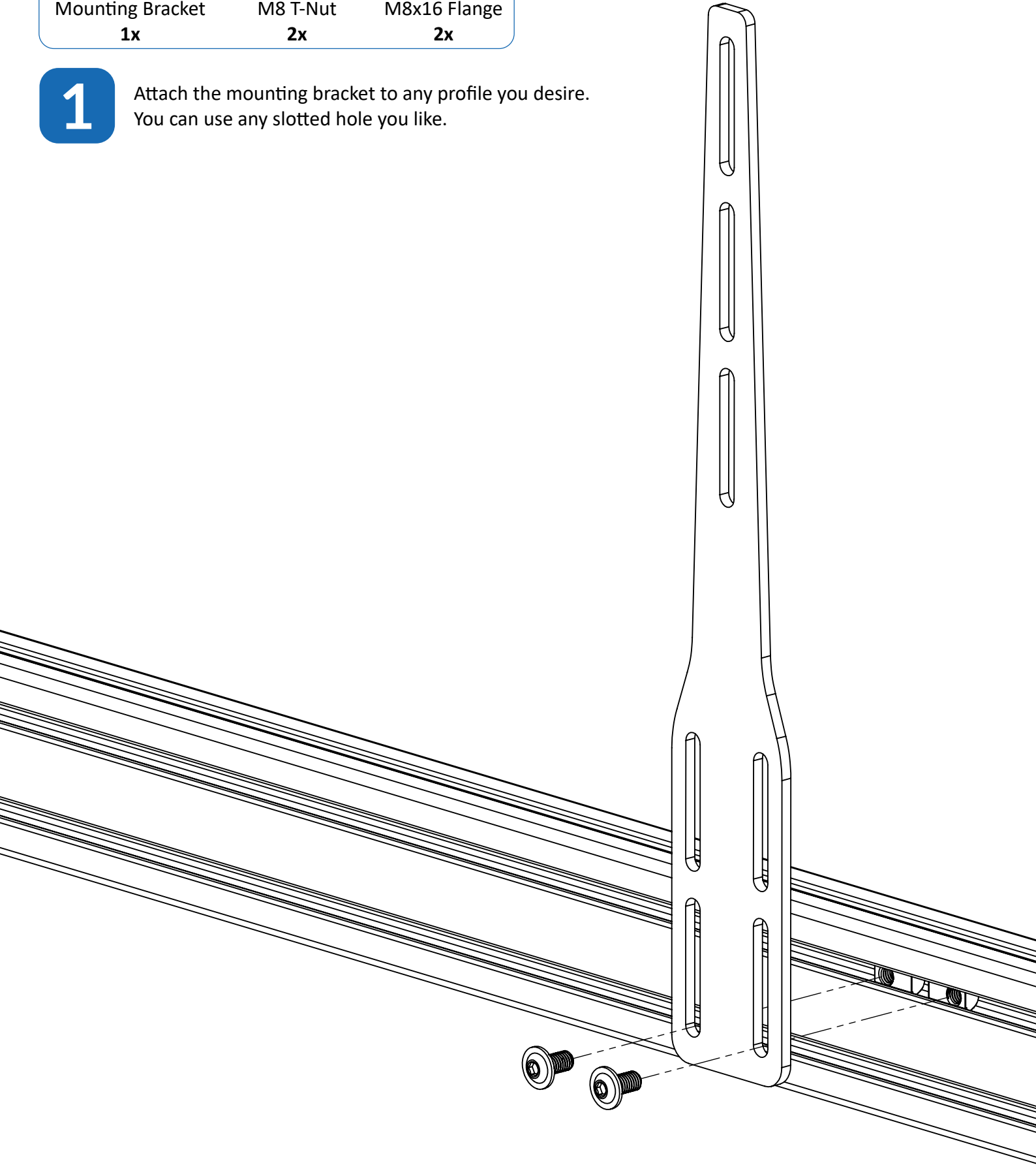

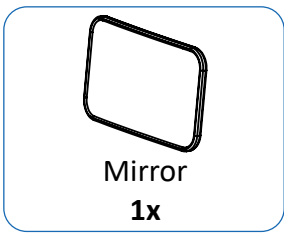

2

Mount the mirror any way you like. After securing the nut, you can tilt and fine tune the mirror.

