

FANATEC CSS MOUNTING PLATE

INSTRUCTION MANUAL

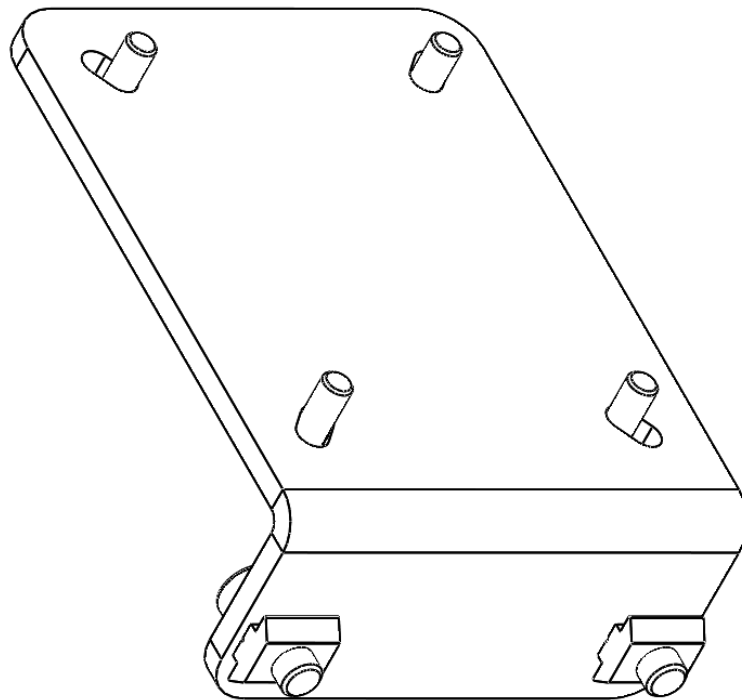

REQUIRED TOOLS:

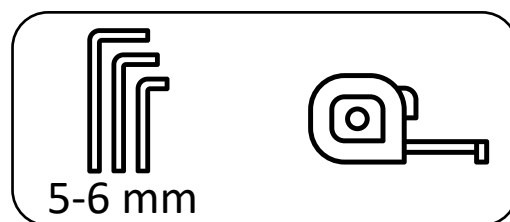

1

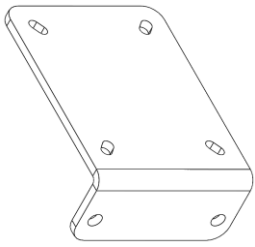

CSS Mounting Plate

1x

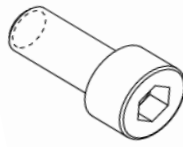

M6x16

4x

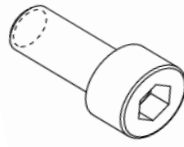

M8x16 (Black)

2x

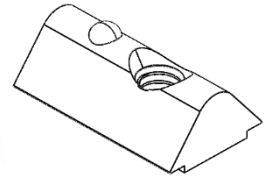

Click-in Nut M8

2x

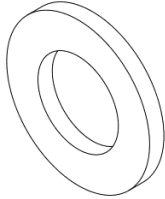

Plain Washer M6

4x

2

